

# COLOR IMAGE RETRIEVAL SYSTEM: A COMPARISON OF APPROACHES

AURA CONCI

EVEREST MATHIAS. M. M. DE CASTRO

CAA- Computação Aplicada e Automação

UFF – Universidade Federal Fluminense

Rua Passo de Pátria, 156, CEP 240210-240, Niterói, RJ, Brasil

{ aconci , mathias }@caa.uff.br

**ABSTRACT.** This paper looks at Content-Based Image Retrieval (CBIR) in terms of the color spaces and distance function used to measure image similarity. Several systems have been designed for image retrieval using this procedure. In these systems, the query result depends, at least, on the underlying color space, the number of histogram bins, and the metric used for histogram matching. Comparison among them is not feasible because they use completely different implementation aspects. We describe a prototype system designed for combining interactively different color spaces and metrics in a common implementation. The purposes are to evaluate the influence of these approaches on the performances of recovering by similarity based on color histograms and to give insight into the relative merits of each one. At the present time, five metrics and four spaces have been considered. The system performs queries through the Internet and applies also a user-consult simulator for performance evaluation. The measures of performance are related to false positives and false negative results.

**KEYWORDS:** Content-based retrieval, database management.

## 1. INTRODUCTION

Image databases have a tendency to become too large to be handled manually. Moreover, these image repositories are generated at increasing rate by a great number of applications [Chang et al. (1997a)]. Automatic browsing on conventional databases uses alphanumeric index for image retrieval. Representation of image content in terms of spatial relationship has been expressed through symbolic strings that capture relative object positions in the scene space [Del Bimbo et al. (1993)]. However, strings or alphanumeric indices are not closely related to human feeling and way to retrieving pictures. Techniques of feature extraction allow queries using a more natural way [Smith--Chang (1996)], they are the core of the Content-Based Image Retrieval (CBIR) system [Gudivada--Raghavan (1995)].

The primary problem to solve is to devise image contents (color, texture, shape, etc.) capturing their essentials [Ren--Means (1997)]. Most of the query systems use shape information for retrieve images from the database. Del Bimbo--Pala (1997) proposed a technique to evaluate similarity rank that is based on elastic matching of sketched templates over the shapes in the image. Huang--Huang (1998) presented a system that retrieves similar shapes scaled, rotated or mirrored. Query by dialog is an interactive approach to shape querying presented by [Del Bimbo et al. (1998)], which is based on the integration of query-by-visual-example and progressive-query approaches. The project QBIC (Query By Image Content) investigates the use of image characteristics of color, texture and form for finding image in database [Niblack et al. (1993)]. The system Photobook searches for new recovery methods for texture, shapes and facial characteristics [Petland et al. (1996)]. The project Chabot [Ogle--Stonebraker, (1995)] developed a system of relational database together with techniques of visual analysis, which integrates color and text annotations for location of images. The C-BIRD (Content-Based Image Retrieval from Databases) was designed to works with color, texture, space location of color, edges orientation, models of objects, and keywords [Zaiane et al. (1997)]. It allows associative search combining keywords with other characteristics. The VIR Image Engine searches images through the color, shapes, texture, and composition in each point of the image. It uses weights for each characteristic and can also combine these features [Bach et al. (1996)]. [Petrakis--Faloutsos (1995)] and [White--Jain (1996, 1997)] has developed efficient index structures for database search.

A survey of classes of images and video, collected on WWW, shows that 85% of visual information consists of color images [Chang et al. (1997-b)]. Methods for reduction of the size of the characteristic color vectors and increasing the speed of recovery colors databases was developed by [Swain--Ballard (1991)] and [Stricker--Orengo (1995)]. Pre-filter techniques that reduce the amount of images in database for similarity computation were accomplished by [Niblack et al. (1993)]. Comparison among different retrieval by color similarity systems is impracticable due to the dependence of the used database and implementation aspects [Randen--Husoy (1997)]. Each system adopts different approaches so that comparative studies on the influence of various aspects become an extremely complex task [Del Bimbo--Pala (1997)]. They stand out their best characteristics, but there is a lack of information on the parameters used for evaluations. Moreover, the questions of why a particular space, quantization level or metric have been selected is not addressed. This work contributes to query systems by offering an implementation that allows a quick and efficient managing of alternatives. Other retrieval systems use only one color space and metric. Ours offers the possibility of interactive combination of metric and color spaces. It permits evaluation of the influence of each aspect determining the relative merits of each approach. This implementation is presented in next section. In Section 3, the evaluation approach and the parameters used for measure the quality of the results is described. Section 4 analyzes the better combinations for retrieving by color and presents some conclusions.

## 2. IMPLEMENTATION CHARACTERISTICS

Query in visual databases is quite different from querying standard alphanumeric bases. The results of such queries are based on similarity matches and not on exact match [Lammens (1994)]. In current approaches for retrieving by color, texture, shape, volume, etc. [Niblack et al. (1993), Srihari (1995), Bach et al. (1996), Zaiane et al. (1997), Stricker--Orengo (1995)], feature vectors are stored as an index for the database [Valkealahti--Oja (1998)]. An evaluation function on the feature space is then used to retrieve images. Given a sample, the distance between its feature vector and each feature vectors of the base are computed. Images with distance less then a predefined threshold or a predefined number of nearest images are retrieved (the latter is easier to user because threshold values frequently depends on theoretic aspects). To represent color images, we use theirs color histograms as feature vectors. The meaning of each element of these histograms depends on the quantization approach, and used color space. The database population is performed associating each RGB color image to its 1D histograms (figure 1).

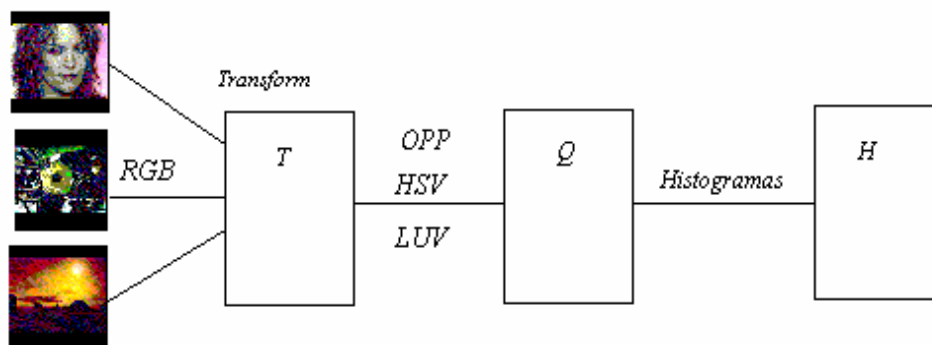

Fig. 1 - Original images to feature vectors: steps of the automatic association.

### 2.1- Color Spaces

Color points constitute a color space. Several color spaces have been used for color representation based on the perceptual concepts. There is no agreement on which is the best choice. Anyway, its desirable characteristics are completeness, uniformity, compactness, and user oriented. Completeness means that it must include all perceptible different colors. Uniformity means that the measured proximity among the colors must be directly related to the psychological similarity among them [Kaiser (1997)]. Compactness means that each color presents a perceptual difference from the other colors. Suitable spaces must be user oriented and based on a intuitive combination of the

three basic attributes of the color (*i.e.* hue-H, saturation-S and intensity or value-V). As color perception is a subjective phenomenon and lacks a universally accepted color space, each group works with a different space. In the implemented system, the used color spaces are an opponent color space-OPP [Swain--Ballard (1991)], HSV [Kaiser--Boyton (1996)] and the CIE-LUV [Xiang (1997)]. The color axes used for quantization on opponent color space is the red/green, *rg*, blue/yellow, *by*, and white/black, *wb*. The *rg*, *by* and *wb* axes are analogous to the opponent color axes used by the human visual system. The linear transform used to get OPP from RGB is given by:

$$\begin{vmatrix} rg \\ by \\ wb \end{vmatrix} = \begin{vmatrix} 1 & -1 & 0 \\ -1 & -1 & 2 \\ 1 & 1 & 1 \end{vmatrix} \times \begin{vmatrix} R \\ G \\ B \end{vmatrix}$$

$$\begin{aligned} rg &= R - G \\ by &= 2 * B - R - G \\ wb &= R + G + B \end{aligned}$$

The CIE-LUV corresponds to human color perception. It very closely resembles uniform color space. For color representation by CIE-LUV,  $L^* u^* v^*$ , we use:

$$\begin{vmatrix} X \\ Y \\ Z \end{vmatrix} = \begin{vmatrix} 0.490 & 0.310 & 0.200 \\ 0.177 & 0.813 & 0.011 \\ 0.000 & 0.010 & 0.990 \end{vmatrix} \times \begin{vmatrix} R \\ G \\ B \end{vmatrix}$$

then:

$$L^* = 116((Y/Y_n)^{\frac{1}{3}}) - 16 \quad \text{if } Y/Y_n > 0.008856$$

$$L^* = 903.3(Y/Y_n) \quad \text{if } Y/Y_n \leq 0.008856$$

$$u^* = 13L^* (u' - u'_n) \quad \text{and} \quad v^* = 13L^* (v' - v'_n)$$

$$\text{where: } u' = 4X/(X + 15Y + 3Z) \quad v' = 9Y/(X + 15Y + 3Z)$$

$$u'_n = 4X_n/(X_n + 15Y_n + 3Z_n) \quad v'_n = 9Y_n/(X_n + 15Y_n + 3Z_n)$$

As a standard, the ITU-R BT.709 (formerly CCIR 709) has been chosen with white illuminant D65: the coordinates  $X_n, Y_n, Z_n$  are 95.05, 100.0, 108.9, respectively. The used color spaces are shown in Figure 2.

OPP Color Model

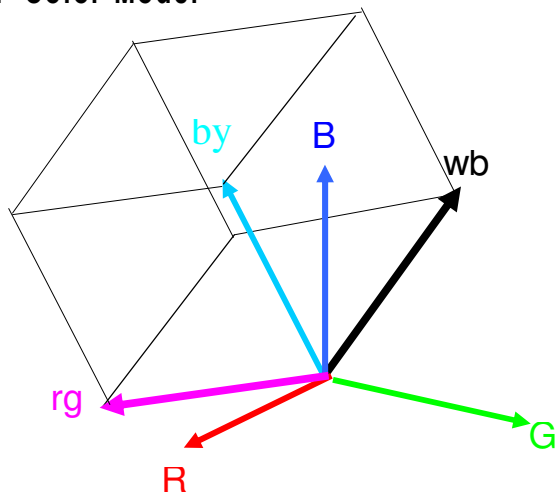

HSV Color Model

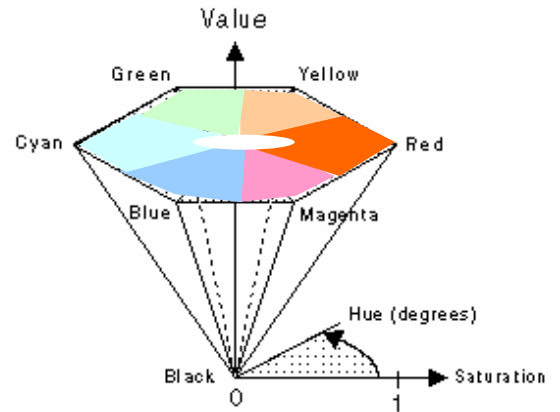

CIE-LUV Color Model

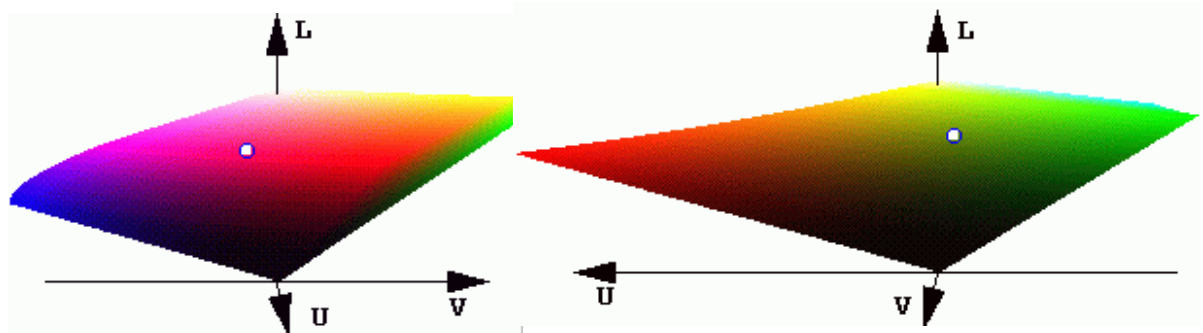

Fig. 2 - Used color spaces

### 2.2- Color Quantization

An image can be represented in a color space by a vector. Color quantization transforms a continuous tone picture into a discrete image. It maps each component of a continuous color signal into a series of colors. Typically a 24-bit RGB format is represented as 256 (for an 8-bit frame buffer display) or less colors. This process inevitably introduces distortion. The visible distortion is a subjective/psychological notion. The question is how to choose the better colors to reproduce the original. A quantization algorithm should distribute any visible distortion throughout the image in order to minimize its perception by an average human observer [Hill et al. (1997)]. Through the quantization we reduced the dimension of the space retaining the information of the color.

We applied uniform quantization, two quantization types were used for the space HSV and a quantization form for each one of the other ones [Braquelair--Brun{1997}]. In CIELUV, 4-8-8 partitions were used in L, U and V axes respectively, resulting in 256 cells. In HSV 162 (18x3x3) and 216 (24x3x3) bins were used. Hue (H) is the attribute associated with the dominant wavelength. Channel H represents the more significant characteristic, its values range from 0° to 360° and it was quantized in two forms: (1) 18 sections of 20° each, and (2) 24 sections of 15° each. In OPP 256 bins have been used: the axis *wb* was partitioned in 4 cells and the axes *rg* and *by* were partitioned in 8 cells each one [Swain--Ballard (1991)].

The process to obtain image histograms implemented in this work uses the following steps. First, each pixel of the image is originally represented as a point in the RGB-color space:  $v_c(R, G, B)$ . A color point is specified by the values of the three channels that contain the information of the color,  $I[x, y]$ , that is  $(v_c) = (I_R[x, y], I_G[x, y], I_B[x, y])$ . Second, the RGB image is transformed to the chosen color space,  $T_c$ . Third the quantization is performed in the space assuming uniform number  $n_1, n_2, n_3$  of bins per axis,  $Q_c$ . Then, each image points is analyzed to compute the 1D normalized histogram with  $m$  cells:

$$h[i] = \frac{1}{XY} \sum_{x=0}^{X-1} \sum_{y=0}^{Y-1} f(x, y) = \begin{cases} 1 & \text{if } (x, y) \text{ color} = i \\ 0 & \text{if } (x, y) \text{ color} \neq i \end{cases} \quad i = 0, 1, 2, \dots, m$$

where  $X, Y$  are the number of pixels in each direction and  $f(x, y) = Q_c^m T_c(v_c)$ ,  $m = n_1 \times n_2 \times n_3 = 256, 216$  or  $162$ . So color histograms are points in an  $m$ -dimensional space related "one-to-one" to the images.

### 2.3- Distance Functions

The idea of exact match (on retrieval) is abandoned and the efforts are driven to meet an adequate value to represent the proximity among images. Distance between two vectors can represent the similarity ( $s$ ) among two images. This distance can be normalized such as  $s \in [0, 1]$ , so that it is a measure of the similarity among the images. In that way, the non-similarity ( $ns$ ) can be expressed for  $ns = 1 - s$ . Five distance functions are used. They are "city-block" metric, Euclidean metric, histogram intersection, average color distance, and the quadratic distance measure form. Denoting  $h_e$  the histogram of the example image and  $h_p$  the histogram of each image present on the database (Fig. 3), then the "city-block" metric or (d1) [Gupta et al. (1997)] and the Euclidean metrics or (d2) are given by [Berman--Shapiro (1997)]:

$$d_{e,p}^\tau = \left[ \sum_{m=0}^{M-1} |h_e[m] - h_p[m]|^\tau \right]^{\frac{1}{\tau}}$$

if  $\tau = 1$  :  $d_{e,p}^1 = \sum_{m=0}^{M-1} |h_e[m] - h_p[m]|$  it represents "city-block" metric and

if  $\tau = 2$  :  $d_{e,p}^2 = \left[ \sum_{m=0}^{M-1} |h_e[m] - h_p[m]|^2 \right]^{\frac{1}{2}}$  it corresponds to Euclidian metric.

If the images has the same number of pixels,  $\{h_e\} = \{h_p\}$  where  $\{h_e\} = \sum_{m=0}^{M-1} h[m]$ , then the distance function

based on histogram intersection or (d3) [Swain--Ballard (1991)] is given by

$$d_{e,p} = 1 - \frac{\sum_{m=0}^{M-1} \min(h_e[m], h_p[m])}{\{h_e\}}$$

The average color distance or (d4) [Hafner et al. (1997)] uses the average magnitude along the three channel of the used space color (R, G, B for instance). The average color of each image is given by  $\bar{x} = (\bar{r}, \bar{b}, \bar{g})$  where  $\bar{r} = \left(\frac{1}{n}\right) \sum_{i=1}^n r(i)$ ,  $\bar{g} = \left(\frac{1}{n}\right) \sum_{i=1}^n g(i)$ ,  $\bar{b} = \left(\frac{1}{n}\right) \sum_{i=1}^n b(i)$ ,  $n$  is the number of image pixels and  $r(i)$ ,  $g(i)$ ,  $b(i)$  are the magnitude of pixel  $i$ , along each channel. The Euclidean distance between their average colors defines the distance between two images.

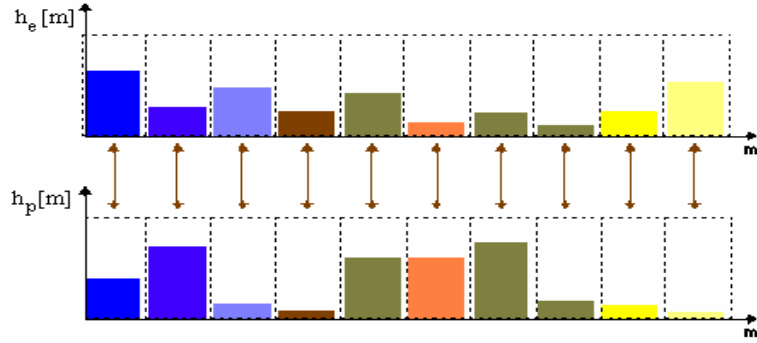

Fig. 3- Comparison between images histograms used for (d1) and (d2)

The quadratic distance measure form or (d5) [Stricker (1994), Ma (1997), Deng--Manjunath (1997)] use the expression:  $(d_{e,p})^2 = (h_e - h_p)^T A (h_e - h_p)$  where  $A$  is a matrix of similarity weights,  $A=[a_{ij}]$ ,  $0 \leq a_{ij} \leq 1$  and  $a_{ii} = 1$  (Fig. 4). Each entry is given by  $a_{ij} = (1 - d_{ij}/d_{max})$ , where  $d_{ij}$  is the Euclidean distance between colors  $i$  and  $j$ , and  $d_{max}$  is the greater distance between colors on the normalized color space [Hafner et al. (1997)]. In the OPP color space (and LUV changing  $wb$ ,  $rg$  and  $by$  with  $L^*$ ,  $u^*$  and  $v^*$ , respectively) the coefficient  $a_{ij}$  for two colors  $m_0 = (rg_e, by_e, wb_e)$  and  $m_1 = (rg_p, by_p, wb_p)$  is

$$a_{m_0 m_1} = 1 - \frac{\left[ (rg_e - rg_p)^2 + (by_e - by_p)^2 + (wb_e - wb_p)^2 \right]^{\frac{1}{2}}}{\sqrt{3}}$$

In polar HSV color space, considering two colors  $m_0 = (h_e, s_e, v_e)$  and  $m_1 = (h_p, s_p, v_p)$  each element of  $A$  is given by:

$$a_{m_0 m_1} = 1 - \frac{\left[ (v_e - v_p)^2 + (s_e \cos(h_e) - s_p \cos(h_p))^2 + (s_e \sin(h_e) - s_p \sin(h_p))^2 \right]^{\frac{1}{2}}}{\sqrt{5}}$$

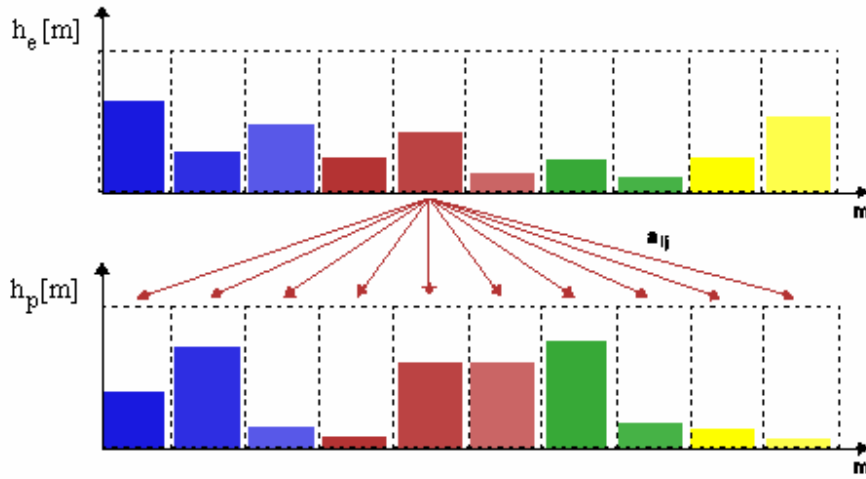

Fig. 4- Defining  $a_{ij}$

## 2.4- User Interface

To allow the user visualization of the different possible combinations among the spaces and metrics, a prototype for Internet was developed. This prototype combines the three modules on figure 5: (1) the interface in the user's equipment; (2) routines for communications control; and (3) routines in the server to process the solicitations on the database [Smith--Chang (1997)]. By means of the interface, one chooses metric, color space, and the image that will be used as sample. It collects these options and through the routine of communications (using HTTP-Hypertext Transfer Protocol) transfers these informations to the server. On the server, programs writing in C, Java and CGI (Common Gateway Interface) receive the customer's information, accomplish searches in image database, and return the results to the customer, in the form of selected images. The prototype system can be found on <http://www.caa.uff.br/~mathias/visual.htm>.

This implementation is designed to be easy to use. Figure 6 presents its dialog page. Simply click directly on any image to find other images in the database that are visually similar on color content. Compare the influence of the color space by changing this and, again, clicking the image. To include the metric influence in your comparative analysis, choose a metric in the select box corresponding to this aspect. Since clicking an image launches a new query, each image can be thought as a query button. In addition to these, the interface provides you with RANDOM, info and HELP buttons. Click button RANDOM to display a new set of images, randomly selected from the database. Click HELP or info to display information about the system or each image. On the Netscape screen of figure 6, the left image on the first line, is the image chosen as model, and the other ones are those found as similar in decreasing order of similarity, using the selected options. Figure 7 shows results obtained with different distance functions using HSV color spaces with 216 bins and the five metrics.

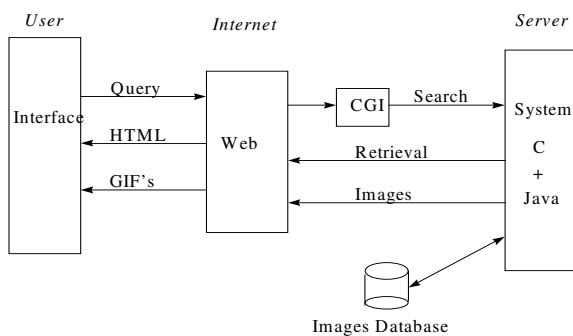

Fig. 5 – Simplified diagram of the prototype.



Fig. 6 – Prototype interface



Fig. 7- First 5 query results using d1, d2 d3 d4 and d5 on the HSV(216)

### 3. EVALUATION PROCEDURES

The evaluation through computer of the visual perception of similar colored images is a complex process [Boker (1995)]. Besides this difficulty some simplifications have to be adopted in the global process. The perception of a color is supposed not to be influenced by the other colors that compose the image. Conditions as illumination, observer's visual adaptation, distance of the observer to the image, and quality of the video can not be considered. When a search of images is requested, a selection process will recover the closest images in the database. In query by similar colors,



the central focus is to accomplish a search for proximity. That is to say, to find those images that, inside a certain threshold, is neighbor to each other. Depending on this threshold, the answer could be either null or the whole database. In the literature there is no method or benchmarks to compare approaches. To evaluate the efficiency of an approach, the obvious measure is the human evaluation. By a visual examination, the classification of the images depends on the observer's subjectivity to characterize them. That is to say, it needs to be accompanied by an exhaustive visual verification of the recovered images. For this purpose a simulator engine was implemented with the objective of computing the grade of adequate recovery of the images [Boloix--Robillard(1995)]. Figure 8 shows how it is designed.

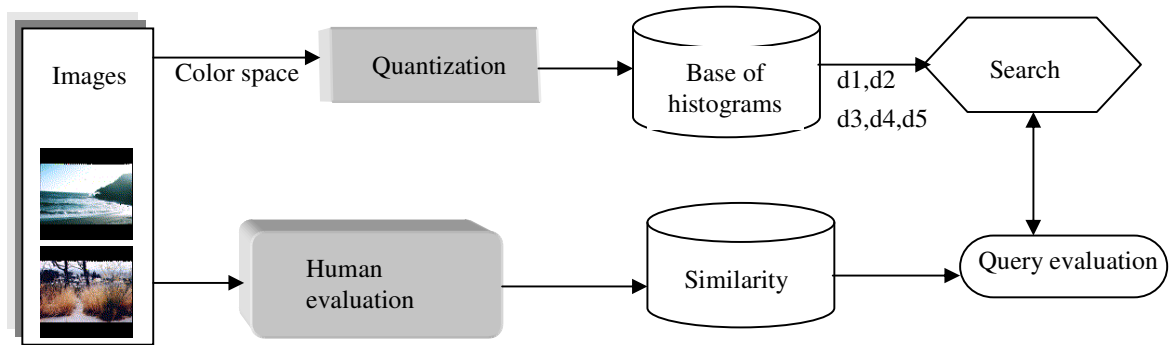

Fig. 8- Query simulator diagram

The obtained results are dependent on a combination among number of images to be recovered, quantization used, color space, metric, and the threshold considered (compare the results on figure 7). To evaluate a group of aspect, we have developed some evaluation measures considering the efficiency of the recovery [Sciascio--Celentano (1997)]. They are designed to be simple but applicable to more generic cases and easily to identify. From the user's point of view, it is important recovered images of similar colors only. The number of false answers (false positive) must be as small as possible, so that the user does not waste time examining unimportant images. The occurrence of false negatives is another valuable characteristic. These are defined as the possibility of not recovering all the images with similar colors. That is, the system answers that two images do not have similar colors, but they (visually) have. In this case some existent images in the database can never be recovered, giving to the user the idea that it does not have the image. The false negatives can happen if the metric or color space lack to consider similar colors [Stricker (1994)].

The projected simulator consists basically of a database with groups of similar images and a search simulation engine. It contains images with all the chromatic nuances. Groups of similar images were identified visually by different users. These images receive the same identification on the simulation system. When an image is recovered, such identification can be used to compute evaluation parameters. The simulator engine has two different functions. The first uses image histograms (in the color space under test) to calculate the distances (using the metric being tested) between each one of the images in a group and all the images in the database. The second function uses these distances to simulate the answers that would be obtained when one of the images is used as a model for recovery of similar images. Whenever an image of the same group is present in a query, it is considered that a significant recovery has been made. The first parameter proposed evaluates the amount of false negative that a group of techniques produces in a recovery. It tries to evaluate the possibility of the system to show all the significant images to the user. An ideal technique would always answer with 100% of the significant images. The maximum number of possible significant images depends on the number of images on the similarity group,  $g$ , and on the number of images the user specify for recovery,  $N_e$ , it should be  $g \times N_e$ . The number of significant images obtained in the choice of all the images of the group will be called  $N_s$ . The effectiveness of the recovery (using a set of metric and space) is given then by the equation:  $N_s \div (g \times N_e) \%$ . Figure 9 represents the behavior of this feature according the number of recovered image of similarity group 1. As larger the value of the effectiveness, smaller is the number of false negative, and better is the used technique. Others graphs and experiences considering the recovered images of each similarity group and the 20 combinations of metrics and spaces results on the effectiveness values can be seen on <http://caa.uff.br/~aconci/colors/effectiveness.htm>.

The second measure proposed evaluates the false positive. In this case, images that are not similar present closer distance than other that are similar. Efficiency calculates the average of images that have to ask for obtaining certain number of significant images. It follows that, starting from these values, the percentages of false positive on the similar images are computed until a certain index. A small amount of false positive is a positive feature of the method. The ideal one would be a method that resulted in 100% of efficiency. To quantify efficiency, it is necessary to count how many results are necessary to search on a query of certain fixed number of significant images,  $N_i$ . It corresponds to answer the following question: "How many images, on the average, must be searched,  $N_r$ , to recover a significant, given number of images in the test group?" The efficiency of the recovery (using a set of metric and space) is given then by:  $N_i \div N_r$  %. The graphs on figure 10 show the efficiency in the recovery of the five and ten more significant images for similarity group 1, considering the 20 possible combinations of metrics and spaces. Obviously, the ideal effectiveness and efficiency would be 100%. Others graphs and experiences can be seen on <http://caa.uff.br/~aconci/colors/efficiency.htm>.

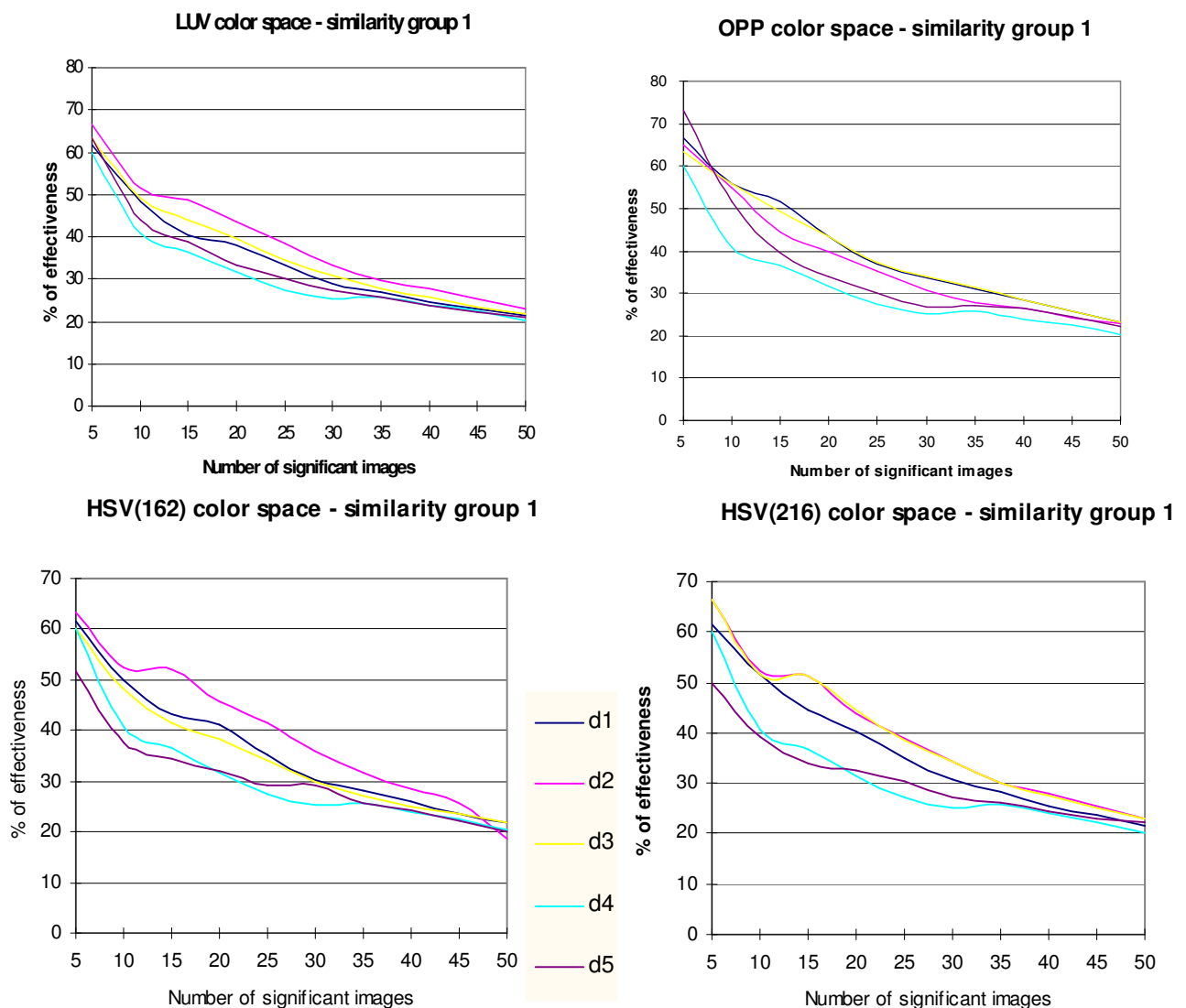

Fig. 9 – Percentage of effectiveness on the first five recoveries for the 20 combination tested on images of similarity group 1

#### 4. CONCLUSIONS

The results of the query by color content on databases are associated to a group of several factors, namely, color space, quantization, metric, composition of the colors that forms the image and the user's subjectivity. In this work, we have presented a framework for CBIR that permits evaluation of the influence of color space and metric on query by global color composition of photographic images. A prototype developed for the evaluation of the quality in the recovery of the images. This uses the Internet as a media for visualizing the results of searches in database, prioritizing the time of answer. In this matter, the system is fast enough to process "on-line". In the implemented system, the result of a query is presented as a group of images. Non-similar images on query may be inevitable, but it is assumed that the user has capacity of discernment for discarding them, and to use only interesting images. The system is interactive and allows that the user (starting from an answer) continues the search in all the database.

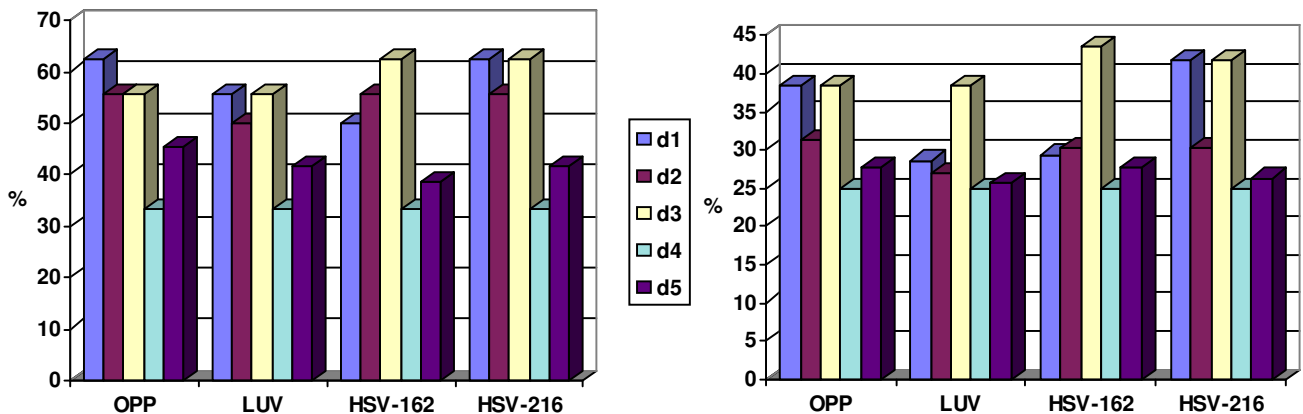

Fig. 10 – Percentage of average effectiveness on the first five and ten recoveries for the 20 combination tested on images of similarity group 1

The color spaces used are: one uniform, HSV (using 2 quantization), and two non-uniforms: OPP, LUV. Twenty combinations of color space and metric are analyzed. The applied metrics are:  $d_1$  or city-block,  $d_2$  or Euclidean, intersection of histograms or  $d_3$ , average color distance ( $d_4$ ) and quadratic function ( $d_5$ ). The result depends on several factors, such as composition of the colors in the images, the color space, quantization, and metric. The evaluation takes into account the average of adequate recovery on groups of similar color images. Two measures described in percentage are proposed for evaluation. Considering the used techniques and all experiments done using the similarity groups (figures 9 and 10 show only those of similarity group 1), the metrics  $d_1$  and  $d_3$  presented the best recovery and the smaller times of answer. The metric  $d_5$  presents the higher computational cost. The best results were obtained with HSV-216 and OPP with the metric  $d_1$  and intersection of histograms ( $d_3$ ).

#### REFERENCES

- J. R. Bach, C. Fuller, A Gupta, A Hampapur, B. Horowitz, R. Humphrey, R. C. Jain, C. Shu, "Virage image search engine: an open framework for image management", *Symposium on Electronic Imaging: science and technology-storage & retrieval for image and video databases IV*, IS&T/SPIE 2670 (1996), 76-87. (<http://www.virage.com>)
- Berman, L.G. Shapiro, "Efficient image retrieval with multiple distance measures", *Proc. SPIE, Storage and Retrieval for Image/Video Databases 3022* (1997), 12-21.
- S. M. Boker, "The Representation of Color Metrics and Mappings in Perceptual Color Space", *Technical Report*, Department of Psychology, University of Virginia, 1995.
- G. Boloix, P. N. Robillard, "A software system evaluation framework", *IEEE Computer*, December (1995), 17-26.

- J.-P. Braquelaire, L. Brun, "Comparison and Optimization of Methods of Color Image Quantization", *IEEE Transaction on Image Processing*, 6, July (1997-a), 1048-1052.
- S.-F. Chang, J. R. Smith, M. Beigi, A. Benitez, "Visual Information Retrieval from Large Distributed Online Repositories:", *Communications ACM* 12 (1997), 63-71.
- S.-F. Chang, W. Chen, H. Meng, H. Sundaram, D. Zhong, "VideoQ: an automatic content-based video search system using visual cues", *Proc. ACM Multimedia*, Seattle, Wa., Nov.(1997-b) <http://www.ctr.columbia.edu/videoq>.
- A. Del Bimbo, M. Campanai, and P. Nesi, "A Three-Dimensional Iconic Environment for Image Database Querying", *IEEE Trans. Software Eng.*, 19, October (1993).
- A. Del Bimbo, P. Pala, "Visual Image Retrieval by Elastic Matching of User Sketches", *IEEE Trans. Pattern Analysis Machine Intell.* 2 (1997), 121-132.
- A. Del Bimbo, M. De Marsico, S. Levialdi, G. Peritore, "Query by dialog: an interactive approach to pictorial querying", *Image and Vision Computing*, 16 (1998) 557-569.
- Y. Deng, B. S. Manjunath, "Content-based search of video using color, texture and motion", *Proc. IEEE ICIP* (1997) <http://copland.ece.ucsb.edu/Demo/video/>.
- V. N. Gudivada, V. V. Raghavan, "Content-Based Image Retrieval Systems", *IEEE Computer*, Sep. (1995) 18-22.
- A.Gupta, S. Santini, R. Jain, "In Search of Information in Visual Media", *Communications ACM* 12 (1997), 34-42.
- J. Hafner, H. S. Sawhney, W. Equitz, M. Flickner and W. Niblack, "Efficient Color Histogram Indexing for Quadratic Form Distance Functions", *IEEE Trans. Pattern Analysis Machine Intell.* 7, (1997) 729-736.
- Hill, Th. Roger, F. W. Vorhagen, "Comparative analysis of the quantization of color spaces on the basis of the CIELAB color-difference formula", *ACM Transaction on Graphics* 2 (1997), 109-154.
- C.-L. Huang, D.H. Huang, "A content-based image retrieval system", *Image and Vision Computing*, 16 (1998) 149-163.
- P.K. Kaiser, *The Joy of Visual Perception*. A WEB Book (<http://www.yorku.ca/faculty/academic/pkaiser/eye/thejoy.htm>), 1997.
- P. K. Kaiser, R. M. Boyton, *Human Color Vision*, Optical Society of America, 2<sup>nd</sup> Ed., Washington, D.C., 1996.
- G. J. Klinker, *A physical Approach to Color Image Understanding*, Wellesley, Massachusetts, 1993.
- J. M. Lammens, "A computational model of color perception and color naming: a case study of symbol grounding for natural language semantics", Ph. D. Thesis, State University of New York at Buffalo, Computer Science Department, 1994.
- W. Y. Ma, Y. Deng B. S. Manjunath, "Tools for texture/color based search of images", *Proc. of SPIE*, Human Vision and Electronic Imaging II, 3106 (1997), 496-507.
- W. Niblack, R. Barber, W. Equitz, M. Flickner, E. Glasman, D. Petkovic, P. Yanker, C. Faloutsos, "The QBIC project: Querying images by content using color, texture and shape", *Storage and Retrieval for Image and Video Databases*, *SPIE* 1908 (1993) (<http://www.qbic.almadem.ibm.com/~qbic>).
- V.E Ogle, M. Stonebraker, "Chabot: Retrieval from a relational database of images", *IEEE Computer* 9 (1995), 40-48.

- Pentland, R. W. Picard, S. Sclaroff, "Photobook: content-based manipulation of databases", *Int. J. Computer Vision*, 3 (1996), 233-254 (<http://www-white.media.mit.edu/~tpmink/photobook>), (<http://www.media.mit.edu/vismod/>).
- E. G. M. Petrakis, C. Faloutsos, "Similarity searching in large databases", *Technical Report 3388*, Department of Computer Science, University of Maryland, 1995.
- T. Randen, J. H. Husoy, "Image Content Search by Color and Texture Properties", *Proc. IEEE ICIP*, Vol. 1, No 417 (1997) 580-583
- Z. Ren, R. W. Means, "Context Vector Approach to Image Retrieval", *Proc. IEEE ICIP*, Vol. 1, No 407 (1997), 1011-1014.
- E. D. Sciascio, A. Celentano, "Similarity evaluation in image retrieval using simple features", *Proc. SPIE*, Vol. 3022, Storage and Retrieval for Image and Video Databases V (1997), 467-477.
- J. R. Smith, S.F. Chang, "Local color and texture extraction and spatial query", *Proc. IEEE ICIP*, 3 (1996), 1011-1014.
- J. Smith, S. F. Chang, "Visually searching the Web for content", *IEEE Multimedia* 4, (1997) 12-20.
- R. K. Srihari, "Automatic indexing and content-based retrieval of captioned images", *IEEE Computer*, 9 (1995) 49-56.
- S. A. Stricker, "Bounds for discrimination power of color indexing techniques", *Proc. SPIE Storage and Retrieval for Image and Video Databases II*, (1994), 15-24.
- M. Stricker, M. Orengo, "Similarity of Color Images", Storage and Retrieval for Image and Video Databases III, *SPIE* 2420 (1995).
- M. J. Swain, D. H. Ballard, "Color Indexing", *Int. J. Computer Vision*, 1 (1991), 11-32.
- K. Valkealahti, E. Oja, "Reduce Multidimensional Co-Occurrence Histograms in Texture Classification", *IEEE Transactions on Pattern Analysis and Machine Intelligence*, vol. 20, No. 1, January, (1998) 90-94.
- A. White, R. Jain, "Similarity Indexing with the SS-tree", *Proc. 12th. IEEE International Conference on Data Engineering*, New Orleans, February. 1996.
- A White, R. Jain, "ImageGREP: Fast Visual Matching in Image Databases", *Proc. of the SPIE: Storage and Retrieval for Image and Video Databases V*, San Jose, CA, 3022, (1997), 96-107.
- Z. Xiang, "Color Image Quantization by Minimizing the Maximum Intercluster Distance", *ACM Transaction on Graphics* 3 (1997), 260-276.
- R. Zaiane, Z Li, B. Yan, "C-BIRD - Content Based Image Retrieval from Digital Libraries", Vision and Media Laboratory, Simon Fraser University- Canada, 1997. <http://jupiter.cs.sfu.ca/cbird/CBIRD.cgi>

## ACKNOWLEDGMENT

This work was partially supported by project FINEP/RECOPE SAGE #0626/96 and CNPq (302649/87.5).